

# U-GAGE™ S18U Series Sensors with Discrete Output

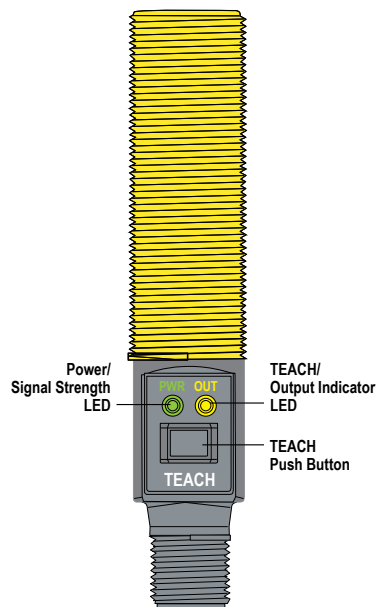

## Datasheet

18 mm Ultrasonic Sensors with TEACH-mode programming



- Fast, easy-to-use TEACH-Mode programming; no potentiometer adjustments
- Short dead zone
- One NPN and one PNP output
- Two bi-colored status LEDs
- Rugged encapsulated design for harsh environments
- Choose 2 meter or 9 meter unterminated cable, or 5-pin Euro-style QD connector
- Wide operating range of  $-20\text{ }^{\circ}\text{C}$  to  $+60\text{ }^{\circ}\text{C}$  ( $-4\text{ }^{\circ}\text{F}$  to  $+140\text{ }^{\circ}\text{F}$ )
- Choose either straight or right-angle housing
- Temperature compensation
- Configurable for normally open or normally closed operation
- Fast response time (5 milliseconds)



**WARNING:** Not To Be Used for Personnel Protection

Never use this device as a sensing device for personnel protection. Doing so could lead to serious injury or death. This device does not include the self-checking redundant circuitry necessary to allow its use in personnel safety applications. A sensor failure or malfunction can cause either an energized or de-energized sensor output condition.

## Models

Model Number	Sensing Range	Cable <sup>1</sup>	Supply Voltage	Output	Housing Configuration
S18UBA	30 mm to 300 mm (1.2 in to 11.8 in)	5-wire, 2 m (6.5 ft) cable	10 V dc to 30 V dc	Bipolar NPN/PNP	Straight
S18UBAQ		5-pin Euro style QD			
S18UBAR		5-wire, 2 m (6.5 ft) cable			Right-Angle
S18UBARQ		5-pin Euro style QD			



NOTE: Information about discrete models is available at <http://www.bannerengineering.com>.

## Status Indicators

Power On/Off LED State	Indicates
Off	The power is off
On red	The target is weak or is outside of the sensing range
On green	The sensor is operating normally, target is good

<sup>1</sup>

- 9 m cables are available by adding suffix "W/30" to the model number of any cabled sensor (for example, S18UBA W/30).
- A model with a QD connector requires a mating cable.



Output/Teach LED State	Indicates
Off	The target is outside of the window limits (normally open operation)
On yellow	The target is within the window limits (normally open operation)
On red	The sensor is in TEACH mode and is waiting for the first limit
Flashing red	The sensor is in TEACH mode and is waiting for the second limit

## Wiring Diagrams

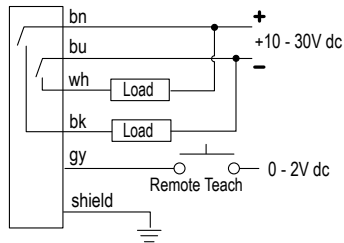

Figure 1. Cabled Models

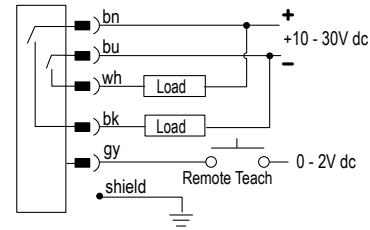

Figure 2. QD Models



NOTE: It is recommended that the shield wire be connected to earth ground or DC common.

## Principles of Operation

Ultrasonic sensors emit one or multiple pulses of ultrasonic energy, which travel through the air at the speed of sound. A portion of this energy reflects off the target and travels back to the sensor. The sensor measures the total time required for the energy to reach the target and return to the sensor. The distance to the object is then calculated using the following formula:  $D = ct \div 2$

D = distance from the sensor to the target  
 c = speed of sound in air  
 t = transit time for the ultrasonic pulse

To improve accuracy, an ultrasonic sensor may average the results of several pulses before outputting a new value.

## Temperature Effects

The speed of sound is dependent upon the composition, pressure and temperature of the gas in which it is traveling. For most ultrasonic applications, the composition and pressure of the gas are relatively fixed, while the temperature may fluctuate.

In air, the speed of sound varies with temperature according to the following approximation:

In metric units:  $C_{m/s} = 20 \sqrt{273 + T_C}$

In English units:  $C_{ft/s} = 49 \sqrt{460 + T_F}$

$C_{m/s}$  = speed of sound in meters per second

$C_{ft/s}$  = speed of sound in feet per second

$T_C$  = temperature in °C

$T_F$  = temperature in °F

## Temperature Compensation

Changes in air temperature affect the speed of sound, which in turn affects the distance reading measured by the sensor. An increase in air temperature shifts both sensing window limits closer to the sensor. Conversely, a decrease in air temperature shifts both limits farther away from the sensor. This shift is approximately 3.5% of the limit distance for a 20° C change in temperature.

The S18U series ultrasonic sensors are temperature compensated. This reduces the error due to temperature by about 90%. The sensor will maintain its window limits to within 1.8% over the -20° to +60° C (-4° to +140° F) range.



NOTE:

- Exposure to direct sunlight can affect the sensor's ability to accurately compensate for changes in temperature.
- If the sensor is measuring across a temperature gradient, the compensation will be less effective.
- The temperature warmup drift upon power-up is less than 1.7% of the sensing distance. After 10 minutes, the apparent distance will be within 0.3% of the actual position. After 25 minutes, the sensing position will be stable.

## Sensor Programming

Use one of two TEACH methods to program the sensor:

- Teach individual minimum and maximum limits
- Use Auto-Window feature to center a sensing window around the taught position

The sensor may be programmed either via its push button, or via a remote switch. Remote programming also may be used to disable the push button, preventing unauthorized personnel from adjusting the programming settings. To access this feature, connect the gray wire of the sensor to 0 V dc to 2 V dc, with a remote programming switch between the sensor and the voltage.



NOTE: The impedance of the Remote Teach input is 12 kΩ.

Programming is accomplished by following the sequence of input pulses. The duration of each pulse (corresponding to a push button “click”), and the period between multiple pulses, are defined as “T”: 0.04 seconds < T < 0.8 seconds.

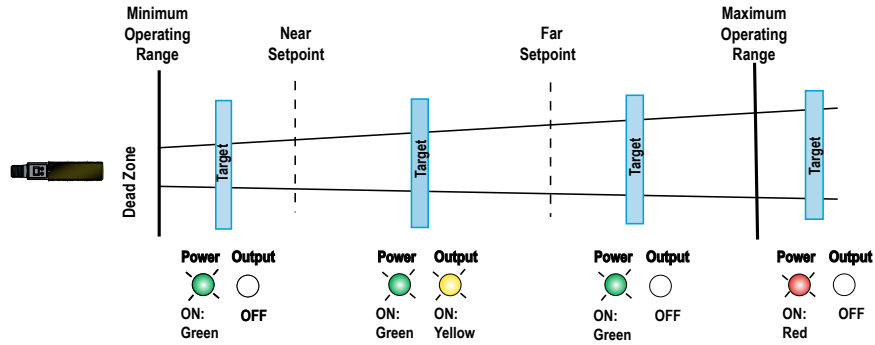

Figure 3. TEACH Interface

## Teach Minimum and Maximum Limits



NOTE:

- The sensor returns to Run mode if the first Teach condition is not registered within 120 seconds
- After the first limit is taught, the sensor remains in Program mode until the Teach sequence is finished
- To exit Program mode without saving any changes, press and hold the programming push button > 2 seconds (before teaching the second limit). The sensor reverts to the last saved limits

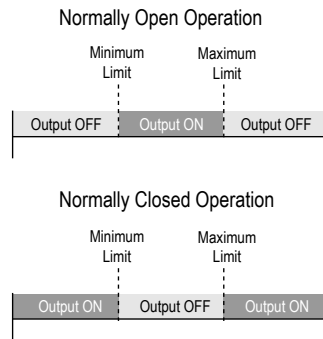

Figure 4. Teaching independent minimum and maximum limits



1. Enter Programming mode.

Method	Action	Result
Push Button <sup>2</sup>	Press and hold the TEACH button	Output LED: On red Power LED: On green (good signal) or On red (no signal)
Remote Input <sup>3</sup>	No action required; the sensor is ready for the first limit	



<sup>2</sup> 0.04 s < “click” < 0.8 s

<sup>3</sup> 0.04 s < T < 0.8 s

2. Present the target for the first limit. The Power LED must be On green.
3. Teach the first limit.

Method	Action		Result
Push Button	Press the TEACH button one time.		Teach Accepted Output LED: Flashes Red
Remote Input	Single-pulse the remote line.		Teach Not Accepted Output LED: On Red

4. Present the target for the second limit. The Power LED must be On green.
5. Teach the second limit.

Method	Action		Result
Push Button	Press the TEACH button one time.		Teach Accepted Output LED: Yellow or OFF
Remote Input	Single-pulse the remote line.		Teach Not Accepted Output LED: Flashes Red

### Teaching Limits Using the Auto-Window Feature

Teaching the same limit twice for the same output automatically centers a 10 mm window on the taught position.



**NOTE:**

- The sensor returns to Run mode if the first Teach condition is not registered within 120 seconds
- After the first limit is taught, the sensor remains in Program mode until the Teach sequence is finished
- To exit Program mode without saving any changes, press and hold the programming push button > 2 seconds (before teaching the second limit). The sensor reverts to the last saved limits

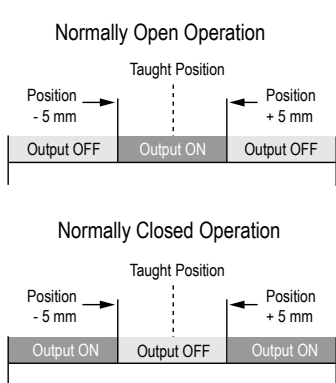

Figure 5. Using the Auto-Window feature for programming each output

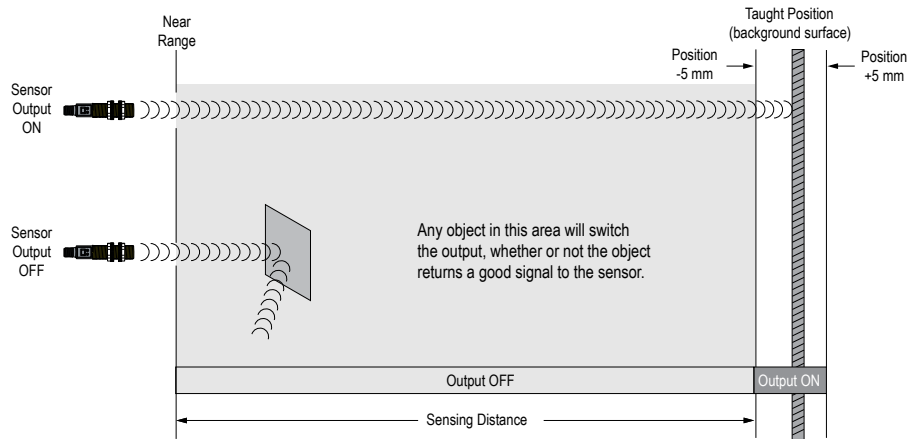





Figure 6. An application for the Auto-Window feature (retroreflective mode)

1. Enter Programming mode.



Method	Action		Result
Push Button <sup>4</sup>	Press and hold the TEACH button		Output LED: On red Power LED: On green (good signal) or On red (no signal)
Remote Input <sup>5</sup>	No action required; the sensor is ready for the first limit		

2. Position the target for the center of the window. The Power LED must be On green.
3. Teach the limit.

<sup>4</sup> 0.04 s < "click" < 0.8 s  
<sup>5</sup> 0.04 s < T < 0.8 s

Method	Action		Result
Push Button	Press the TEACH button one time.		Teach Accepted Output LED: Flashing Red
Remote Input	Single-pulse the remote line.		Teach Not Accepted Output LED: ON Red

4. Teach the limit a second time.

Method	Action		Result
Push Button	Without moving the target, press the TEACH button one time.		Teach Accepted Output LED: Yellow or OFF
Remote Input	Without moving the target, single-pulse the remote line.		Teach Not Accepted Output LED: Flashing Red

### Normally Open/Normally Closed Operation Select

The sensor can be configured for either normally open or normally closed operation via the remote teach wire (gray). A series of three pulses on the line will toggle between normally open and normally closed operation. Normally open is defined as the output energizing when the target is present. Normally closed is defined as the output energizing when the target is absent. See [Figure 4](#) on page 3 and [Figure 5](#) on page 4.

To toggle between normally open or normally closed operation, triple-pulse the remote line. Either Normally Open or Normally Closed operation is selected, depending on previous condition.

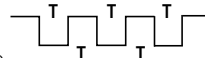

the remote line. Either Normally Open or

### Lock the Buttons

Enable or disable the buttons to prevent unauthorized adjustment of the program settings.

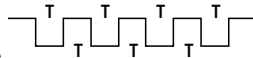

To lock or unlock the buttons, four-pulse the remote line. The buttons are enabled or disabled, depending on the previous condition.

the remote line. The buttons are enabled or disabled, depending on the

## Specifications

**Sensing Range**  
30 to 300 mm (1.2 in to 11.8 in)

**Supply Voltage**  
10 V dc to 30 V dc (10% maximum ripple); 65 mA max. (exclusive of load), 40 mA typical @ 25V input

**Ultrasonic Frequency**  
300 kHz, rep. rate 2.5 ms

**Supply Protection Circuitry**  
Protected against reverse polarity and transient voltages

**Output Configuration**  
SPST solid-state switch conducts when target is sensed within sensing window; one NPN (current sinking) and one PNP (current sourcing) output in each model.

**Output Protection**  
Protected against short circuit conditions

**Output Ratings**  
100 mA maximum  
OFF-state leakage current: < 5 microamps  
NPN saturation: < 200 mV @ 10 mA and < 600 mV @ 100 mA  
PNP saturation: < 1.2 V @ 10 mA and < 1.6 V @ 100 mA

**Output Response Time**  
5 milliseconds

**Delay at Power-Up**  
300 milliseconds

**Temperature Effect**  
0.02% of distance/ °C

**Repeatability**  
0.5 mm

**Minimum Window Size**  
5 mm

**Hysteresis**  
0.7 mm

**Adjustments**  
Sensing window limits: TEACH-Mode programming of near and far window limits may be set using the push button or remotely via TEACH input

**Indicators**  
Range Indicator (Red/Green)  
Green—Target is within sensing range  
Red—Target is outside sensing range  
OFF—Sensing power is OFF

Teach/Output I Indicator (Amber/Red)  
Yellow—Target is within taught limits  
OFF—Target is outside taught window limits  
Red—Sensor is in TEACH mode

**Remote TEACH I Input**  
Impedance: 12 kΩ

**Construction**  
Threaded Barrel: Thermoplastic polyester  
Push Button: Santoprene  
Push Button Housing: ABS/PC  
Lightpipes: Acrylic

**Operating Conditions**  
Temperature: -20 °C to +60 °C (-4 °F to +140 °F)

**Connections**  
2 m (6.5 ft) or 9 m (30 ft) shielded 5-conductor (with drain) PVC jacketed attached cable or 5-pin Euro-style quick-disconnect

**Environmental Rating**  
Leakproof design is rated IEC IP67; NEMA 6P

**Vibration and Mechanical Shock**  
All models meet Mil Std. 202F requirements. Method 201A (vibration: 10 Hz to 60 Hz max., double amplitude 0.06 inch, maximum acceleration 10G). Also meets IEC 947-5-2 requirements: 30G 11 ms duration, half sine wave.

**Temperature Warmup Drift**  
Less than 1.7% of sensing distance upon power-up (see Temperature Compensation)

**Application Notes**  
Objects passing inside the specified near limit may produce a false response.

**Certifications**



## Dimensions

Straight Housing

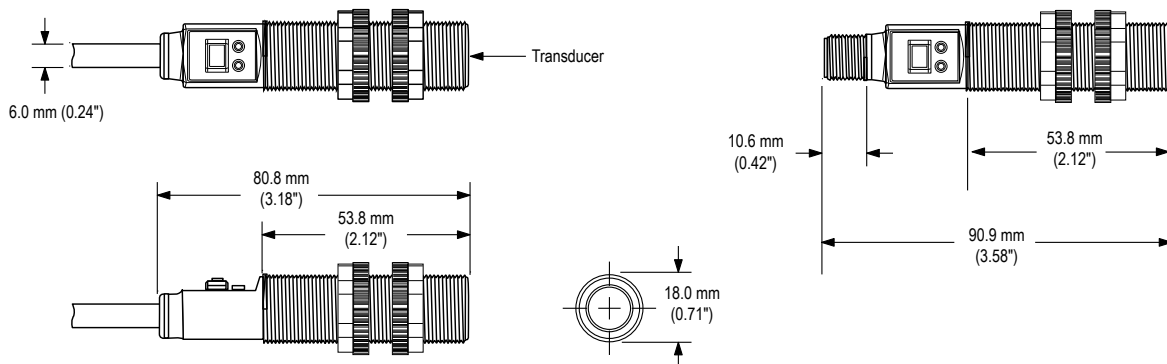

Right-Angle Housing

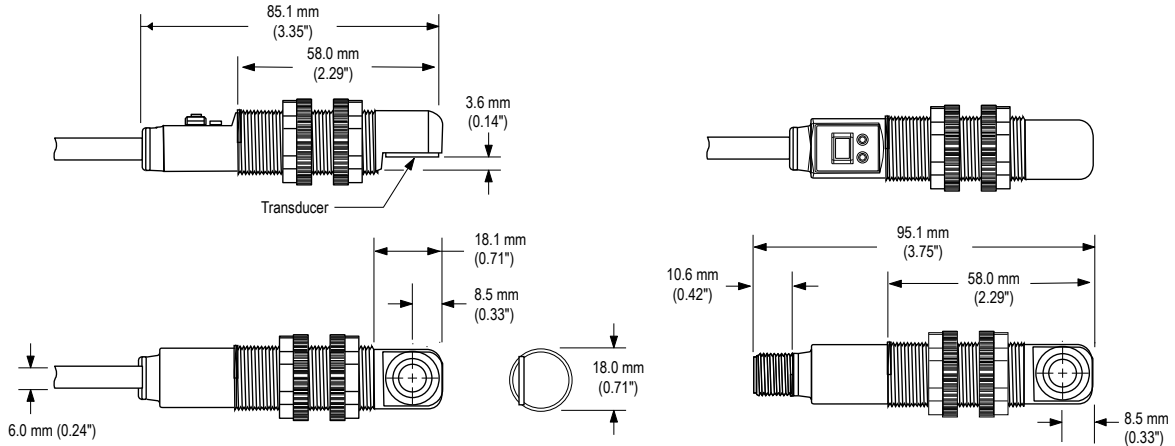

Response Curves

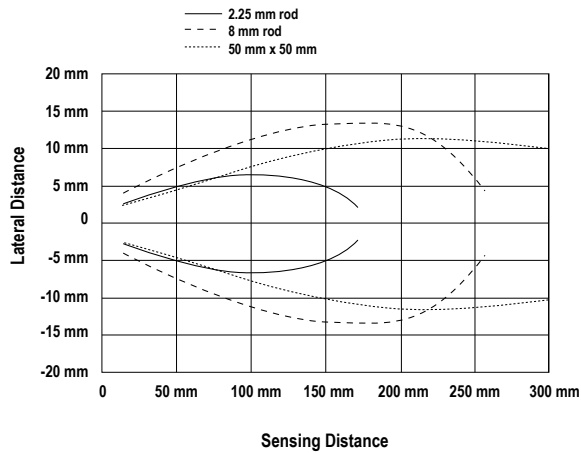

Figure 7. Effective Beam Pattern (Typical)

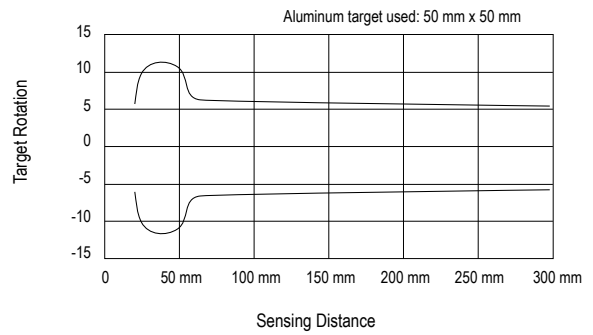

Figure 8. Maximum Target Rotation Angle

Accessories

Quick-Disconnect Cables

5-Pin Threaded M12/Euro-Style Cordsets—with Shield				
Model	Length	Style	Dimensions	Pinout (Female)
MQDEC2-506	1.83 m (6 ft)	Straight		<p>1 = Brown 2 = White 3 = Blue 4 = Black 5 = Gray</p>
MQDEC2-515	4.57 m (15 ft)			
MQDEC2-530	9.14 m (30 ft)			
MQDEC2-550	15.2 m (50 ft)			

5-Pin Threaded M12/Euro-Style Cordsets—with Shield				
Model	Length	Style	Dimensions	Pinout (Female)
MQDEC2-506RA	1.83 m (6 ft)	Right-Angle		
MQDEC2-515RA	4.57 m (15 ft)			
MQDEC2-530RA	9.14 m (30 ft)			
MQDEC2-550RA	15.2 m (50 ft)			

## Brackets

### SMB18A

- Right-angle mounting bracket with a curved slot for versatile orientation
- 12-ga. stainless steel
- 18 mm sensor mounting hole
- Clearance for M4 (#8) hardware

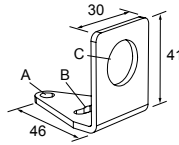

Hole center spacing: A to B = 24.2  
 Hole size: A =  $\varnothing$  4.6, B = 17.0 x 4.6, C =  $\varnothing$  18.5

### SMB18SF

- 18 mm swivel bracket with M18 x 1 internal thread
- Black thermoplastic polyester
- Stainless steel swivel locking hardware included

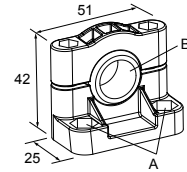

Hole center spacing: A = 36.0  
 Hole size: A =  $\varnothing$  5.3, B =  $\varnothing$  18.0

### SMB18UR

- 2-piece universal swivel bracket
- 300 series stainless steel
- Stainless steel swivel locking hardware included
- Mounting hole for 18 mm sensor

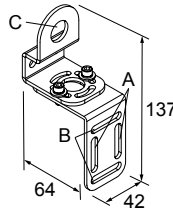

Hole center spacing: A = 25.4, B = 46.7  
 Hole size: B = 6.9 x 32.0, C =  $\varnothing$  18.3

## Banner Engineering Corp. Limited Warranty

Banner Engineering Corp. warrants its products to be free from defects in material and workmanship for one year following the date of shipment. Banner Engineering Corp. will repair or replace, free of charge, any product of its manufacture which, at the time it is returned to the factory, is found to have been defective during the warranty period. This warranty does not cover damage or liability for misuse, abuse, or the improper application or installation of the Banner product.

THIS LIMITED WARRANTY IS EXCLUSIVE AND IN LIEU OF ALL OTHER WARRANTIES WHETHER EXPRESS OR IMPLIED (INCLUDING, WITHOUT LIMITATION, ANY WARRANTY OF MERCHANTABILITY OR FITNESS FOR A PARTICULAR PURPOSE), AND WHETHER ARISING UNDER COURSE OF PERFORMANCE, COURSE OF DEALING OR TRADE USAGE.

This Warranty is exclusive and limited to repair or, at the discretion of Banner Engineering Corp., replacement. IN NO EVENT SHALL BANNER ENGINEERING CORP. BE LIABLE TO BUYER OR ANY OTHER PERSON OR ENTITY FOR ANY EXTRA COSTS, EXPENSES, LOSSES, LOSS OF PROFITS, OR ANY INCIDENTAL, CONSEQUENTIAL OR SPECIAL DAMAGES RESULTING FROM ANY PRODUCT DEFECT OR FROM THE USE OR INABILITY TO USE THE PRODUCT, WHETHER ARISING IN CONTRACT OR WARRANTY, STATUTE, TORT, STRICT LIABILITY, NEGLIGENCE, OR OTHERWISE.

Banner Engineering Corp. reserves the right to change, modify or improve the design of the product without assuming any obligations or liabilities relating to any product previously manufactured by Banner Engineering Corp.

## Copyright Notice

Any misuse, abuse, or improper application or installation of this product or use of the product for personal protection applications when the product is identified as not intended for such purposes will void the product warranty. Any modifications to this product without prior express approval by Banner Engineering Corp will void the product warranties. All specifications published in this document are subject to change: Banner reserves the right to modify product specifications or update documentation at any time. For the most recent version of any documentation, refer to: [www.bannerengineering.com](http://www.bannerengineering.com). © Banner Engineering Corp. All rights reserved.